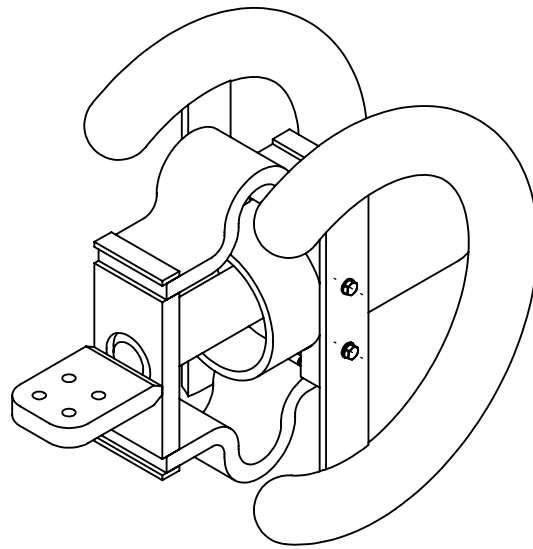
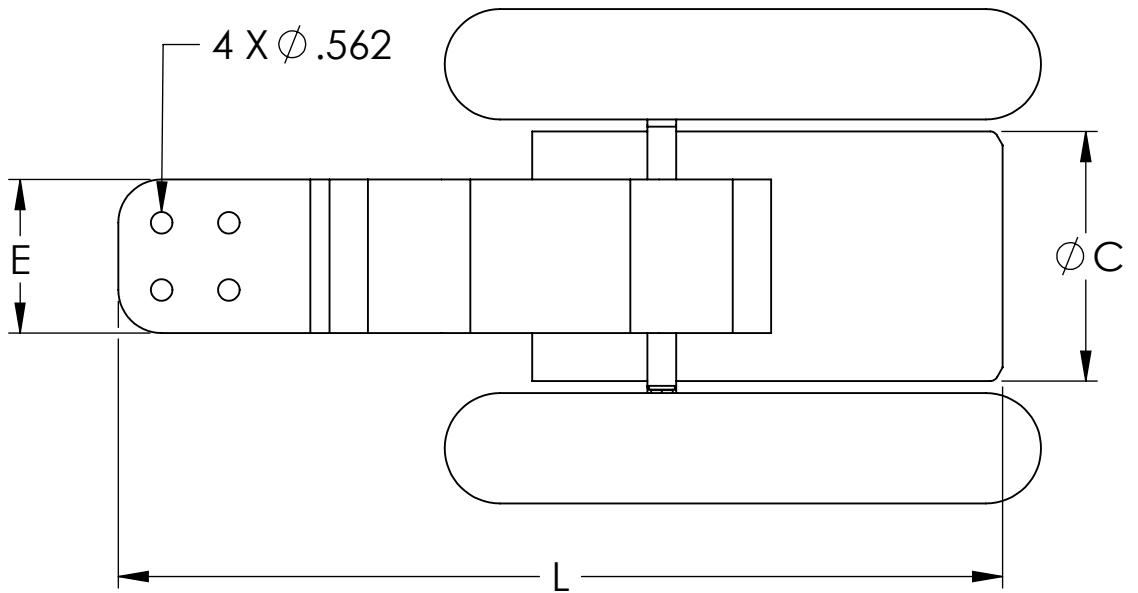
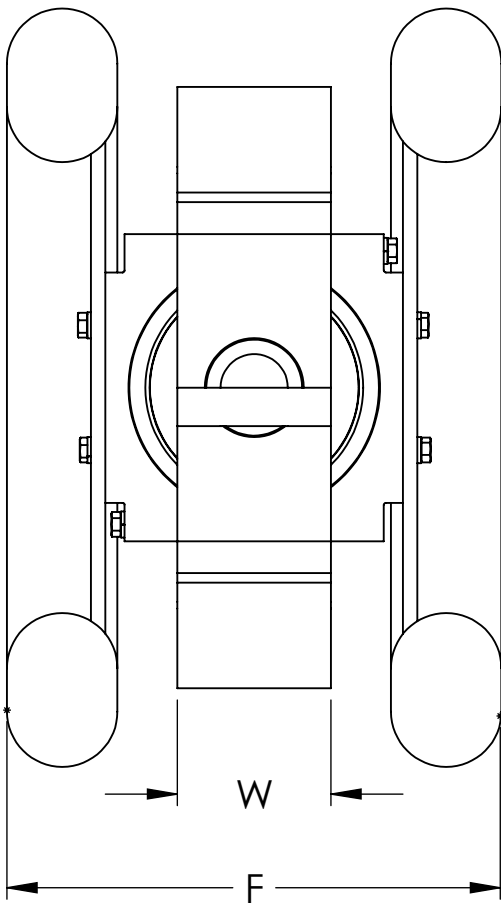

FIGURE 1, PAD RINGS



ISOMETRIC VIEW



THIS DRAWING AND THE INFORMATION CONTAINED HEREIN ARE THE PROPERTY OF DMCPower AND SHALL NOT BE COPIED, REPRODUCED OR DISCLOSED WITHOUT EXPRESS AUTHORIZATION BY DMCPower.

FIGURE 2, PAD // RINGS (-90)

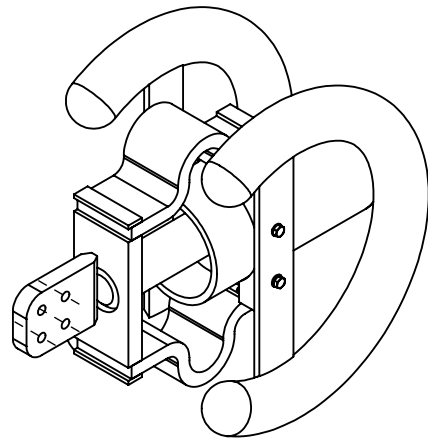

ISOMETRIC VIEW

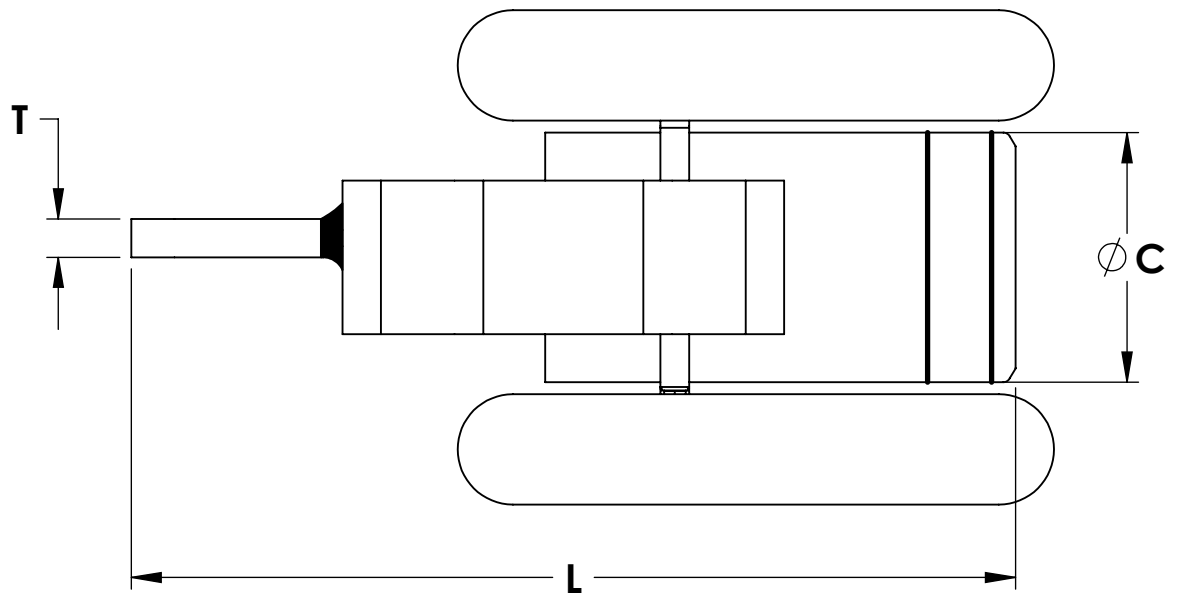
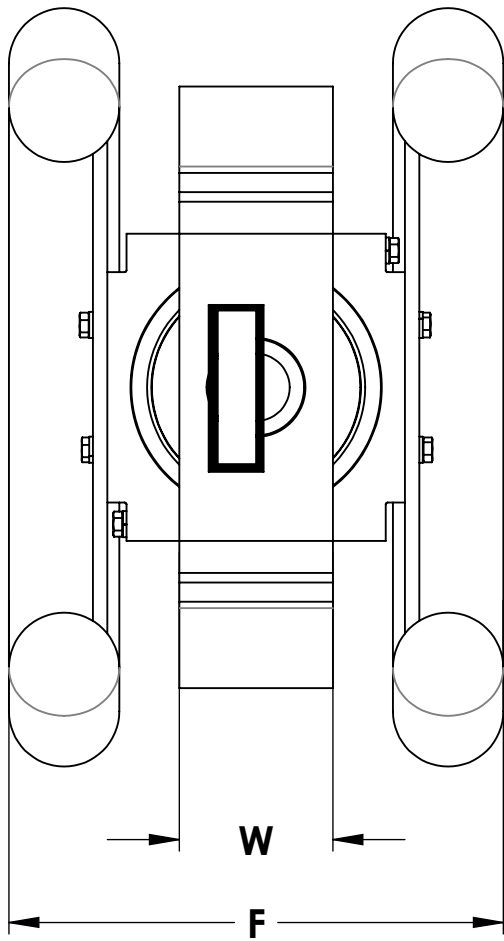

THIS DRAWING AND THE INFORMATION CONTAINED HEREIN ARE THE PROPERTY OF DMCPower AND SHALL NOT BE COPIED, REPRODUCED OR DISCLOSED WITHOUT EXPRESS AUTHORIZATION BY DMCPower.

TABLE: AVAILABLE OPTIONS

ASSEMBLY PART NUMBER	BUS SIZE	ØC	PAD OPTION	E	F	L	T	W
PLK3699D64E1	4	5.500	E1	4.00	11.85	20.03	0.75	4.00
PLK3699D64E1-90								
PLK3699D64E3-90			E3	5.00				
PLK3699D80E1	5	6.500	E1	4.00	12.85		1.00	
PLK3699D80E1-90								
PLK3699D80E3-90			E3	5.00				

LEGEND

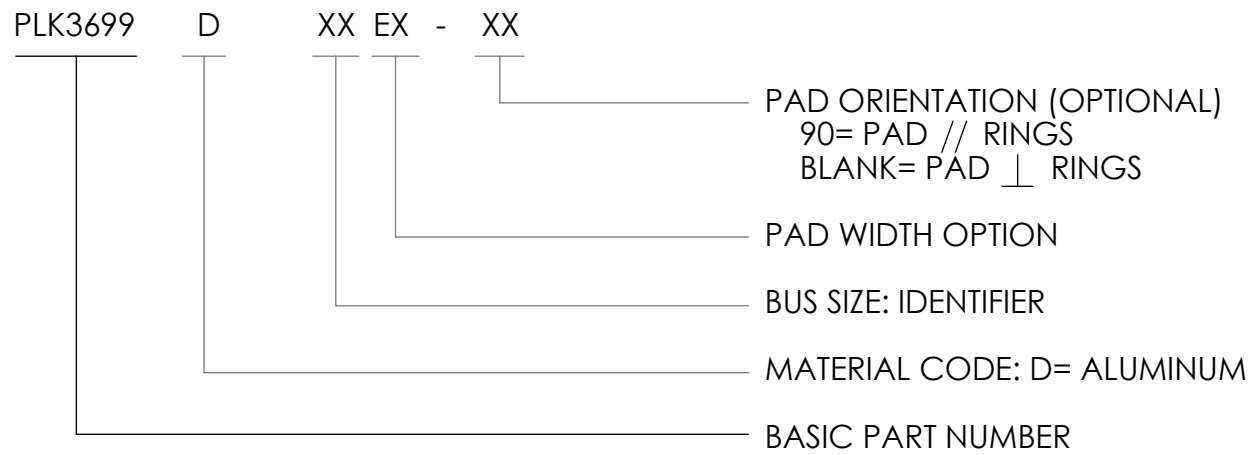

THIS DRAWING AND THE INFORMATION CONTAINED HEREIN ARE THE PROPERTY OF DMCPOWER AND SHALL NOT BE COPIED, REPRODUCED OR DISCLOSED WITHOUT EXPRESS AUTHORIZATION BY DMCPOWER.